

INSTALLATION INSTRUCTIONS

For quick and easy installation of your folding door, read these instructions thoroughly. A few minutes of prior planning will make the job easier and will ensure years of trouble-free use.

The Tools You Will Need

You will need a small #1 Phillips screwdriver, a tape measure, a small nail, and a 3/32" drill for screw pilot holes, a hacksaw or fine tooth saw (saw needed to trim top track for the appropriate width or to trim height of panels if opening is less than 80" high); and masking tape (to secure doors if trimming is necessary.) Safety glasses.

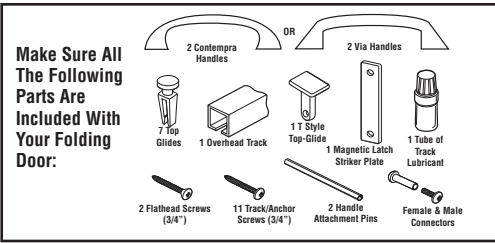

Door Parts Location

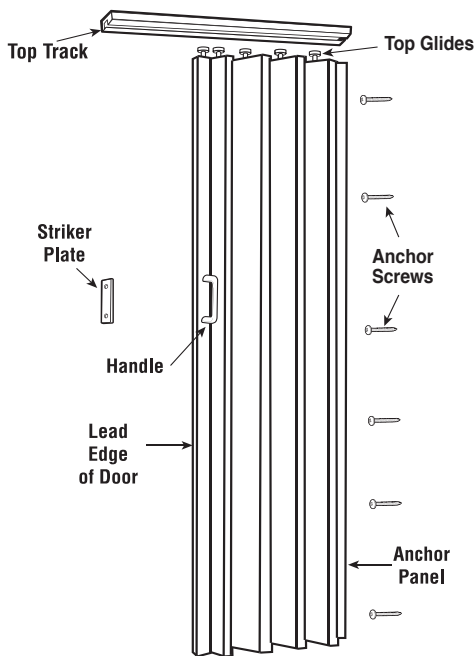

SINGLE DOOR INSTALLATION

1. Measure the Door Opening

If the height of your door opening is approximately 80", you will not need to alter the door itself. If the opening is less than 80" high, the door may be shortened by sawing off excess from the bottom of the door panels (end without holes).

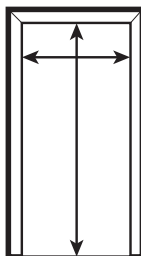

If the opening is less than 80" high: Stack the door panels together, secure with masking tape and cut with a hacksaw or fine tooth saw. Remove the masking tape. Cut the overhead track 1/8" shorter than the width of the opening.

2. Install the Top Track

Position the top track on the top of the door opening so that it is straight and centered.

After making a screw pilot hole (with a nail or 3/32" drill), drive a 3/4" track screw through the screw hole nearest the center of the track. Do not tighten. (Tape may be used to hold the track in place while you mark and drill.)

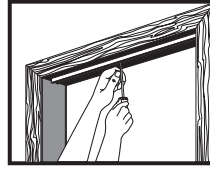

3. Install the Handles

Tap the two handle attachment pins into one handle, then fit the pins through the door panel holes. Press the other handle onto the pins.

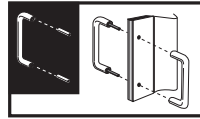

If necessary, you may back one handle with a solid object and tap the other handle alternately over each pin area until the handles are seated. Do not strike the middle of either handle.

4. Install The Top Glides

Position top glides over center holes on top of each full width panel. Snap top glides into place and make sure they are secure.

To secure the lead edge top glide, place the T shaped part inside the lead edge and align the holes. Then insert the female section from the outside hole through the hole in the T shaped glide through the other side of the lead edge. Then insert the threaded male screw into the female part and tighten until snug.

5. Install the Door Panels

Apply track lubricant to each top glide. Swing one end of the overhead track out of the door opening to accept the top glides. Decide if you want the door to open from the left or the right, then slide all top glides onto the track. Stack the panels together near the center screw.

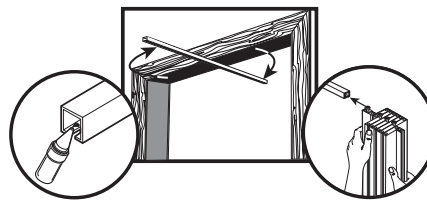

6. Secure The Top Track

Swing the track back to its original position. After making screw pilot holes (with a nail or a 3/32" drill), drive the 3/4" track screws through all track holes. Set all screws as straight and tight as possible to assure smooth operation of the door.



7. Secure The Anchor Panel

Slide the entire door against the non-opening side of the doorway. With the door panel hanging naturally, locate the six holes on the anchor panel where the door will be secured to the jamb. Using the drill, insert the screws and secure the end anchor panel to the jamb.

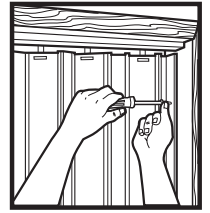

8. Install Magnetic Latch Striker Plate

Place the magnetic latch striker plate against the metal strips on the door edge. Close the door until it strikes the door jamb. Mark the proper location of the latch. Secure the latch to the door jamb with the two flathead screws.

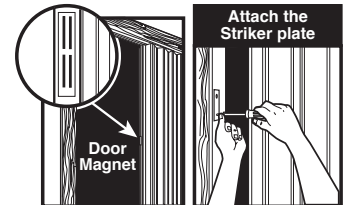

Double Door Installation

1. Measure The Door Opening

Divide the width of the opening by two. Cut each overhead track to this measurement so that when installed, the tracks butt against one another in the center of the door opening.

2. Install One Top Track

On a center line drawn across the top of the door opening, install either half track and install all screws in the half track.

3. Install The Door Panels

Please lubricate the top glides with the lubricant supplied. Install the two doors in the half track with lead edges facing each other. Then install the second track and push one door onto this track. Set a screw at the track center joint and leave the screw projecting down 1/4" to prevent glides from passing the joint.



*Easy-to-install quality
La qualité... facile à installer*

COLONIAL ELEGANCE INC.

3800, Du Tricentenaire
Montreal, Quebec, Canada H1B 5T8

TEL 514-640-1212 • 800-361-2030

FAX 888-640-1744

info@colonialegance.com

www.colonialegance.com